

Standard SCRs, 20A

Main Features

Symbol	Value	Unit
$I_{T(RMS)}$	20	A
V_{DRM}/V_{RRM}	600 to 1000	V
I_{GT}	3 to 25	mA

DESCRIPTION

The 20PT series of silicon controlled rectifiers are high performance glass passivated technology, and are suitable for general purpose applications.

Using clip assembly technology, they provide a superior performance in surge current capabilities.

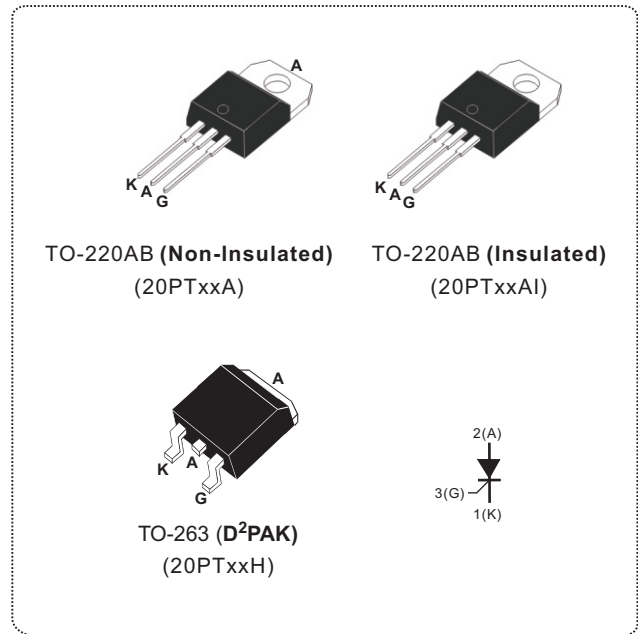

ABSOLUTE MAXIMUM RATINGS

PARAMETER	SYMBOL	TEST CONDITIONS		VALUE	UNIT
RMS on-state current full sine wave (180° conduction angle)	$I_{T(RMS)}$	TO-263/TO-220AB	$T_C=100^\circ\text{C}$	20	A
		TO-220AB insulated	$T_C=80^\circ\text{C}$		
Average on-state current (180° conduction angle)	$I_{T(AV)}$	TO-263/TO-220AB	$T_C=100^\circ\text{C}$	13	A
		TO-220AB insulated	$T_C=80^\circ\text{C}$		
Non repetitive surge peak on-state current (full cycle, T_j initial = 25°C)	I_{TSM}	F = 50 Hz	t = 20 ms	200	A
		F = 60 Hz	t = 16.7 ms	220	
I^2t Value for fusing	I^2t	$t_p = 10 \text{ ms}$		200	A^2s
Critical rate of rise of on-state current $I_G = 2xI_{GT}$, $t_r \leq 100\text{ns}$	dI/dt	F = 60 Hz	$T_j = 125^\circ\text{C}$	50	$\text{A}/\mu\text{s}$
Peak gate current	I_{GM}	$T_p = 20 \mu\text{s}$	$T_j = 125^\circ\text{C}$	4	A
Maximum gate power	P_{GM}	$T_p = 20 \mu\text{s}$	$T_j = 125^\circ\text{C}$	10	W
Average gate power dissipation	$P_{G(AV)}$	$T_j = 125^\circ\text{C}$		1	W
Repetitive peak off-state voltage	V_{DRM}	$T_j = 125^\circ\text{C}$		600 to 1000	V
Repetitive peak reverse voltage	V_{RRM}				
Storage temperature range	T_{stg}			- 40 to + 150	°C
Operating junction temperature range	T_j			- 40 to + 125	

ELECTRICAL SPECIFICATIONS (T _J = 25 °C unless otherwise specified)							
SYMBOL	TEST CONDITIONS			20PTxxxx		Unit	
				D	—		
I _{GT}	V _D = 12V, R _L = 33Ω			Min.	4	3	mA
				Max.	10	25	
V _{GT}				Max.	1.3	1.3	V
V _{GD}	V _D = V _{DRM} , R _L = 3.3KΩ R _{GK} = 220Ω	T _J = 125°C	Min.	0.2	0.2	V	
I _H	I _T = 500mA, Gate open			Max.	10	40	mA
I _L	I _G = 1.2×I _{GT}			Min.	20	60	mA
dV/dt	V _D = 67% V _{DRM} , Gate open	T _J = 125°C	Min.	100	500	V/μs	
V _{TM}	I _T = 40A, t _p = 380μs	T _J = 25°C	Max.	1.6		V	
I _{DRM} I _{RRM}	V _D =V _{DRM} , V _R =V _R RM R _{GK} = 220Ω		T _J = 25°C	Max.	5		μA
			T _J = 125°C	Max.	2		mA
V _{to}	Threshold Voltage		T _J = 125°C	Max.	0.77		V
R _d	Dynamic Resistance		T _J = 125°C	Max.	23		mΩ

THERMAL RESISTANCE					
SYMBOL	Parameter		VALUE	UNIT	
R _{th(j-c)}	Junction to case (DC)		D ² PAK/TO-220AB	1.05	°C/W
			TO-220AB insulated	2.1	
R _{th(j-a)}	S = 1 cm ² Junction to ambient		TO-263(D ² PAK)	45	°C/W
			TO-220AB/TO-220AB insulated	60	

S=Copper surface under tab

PRODUCT SELECTOR					
PART NUMBER	VOLTAGE (xx)			SENSITIVITY	PACKAGE
	600 V	800 V	1000 V		
20PTxxA/20PTxxAI	V	V	V	25 mA	TO-220AB
20PTxxH	V	V	V	25 mA	D ² PAK
20PTxxA-D / 20PTXXAI-D	V	V	x	4-10 mA	TO-220AB
20PTxxH-D	V	V	x	4-10 mA	D ² PAK

ORDERING INFORMATION					
ORDERING TYPE	MARKING	PACKAGE	WEIGHT	BASE Q'TY	DELIVERY MODE
20PTxxA/20PTxxA-D	20PTxxA/20PTxxA-D	TO-220AB	2.0g	50	Tube
20PTxxAI/20PTxxAI-D	20PTxxAI/20PTxxAI-D	TO-220AB (insulated)	2.3g	50	Tube
20PTxxH/20PTxxH-D	20PTxxH/20PTxxH-D	TO-263(D ² PAK)	2.0g	50	Tube

Note: xx = voltage

ORDERING INFORMATION SCHEME

20 PT 06 AI - D

Current

20 = 20A, $I_{T(RMS)}$

SCR series

Voltage Code

06 = 600V
08 = 800V
10 = 1000V

Package type

A = TO-220AB (non-insulated)
AI = TO-220AB (insulated)
H = TO-263 (D²PAK)

I_{GT} Sensitivity

D = 4~10 mA
Blank = 3~25mA

Fig.1 Maximum average power dissipation versus average on-state current.

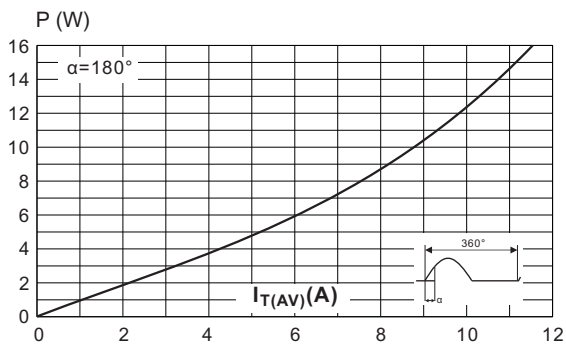

Fig.2 Average and D.C. on-state current versus case temperature.

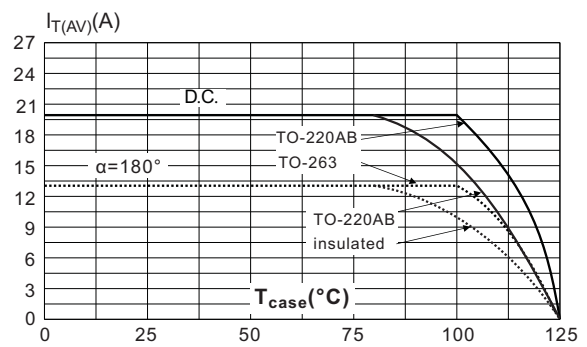

Fig.3 Average and D.C. on-state current versus ambient temperature. (copper surface under tab: S=1cm²) (D²PAK)

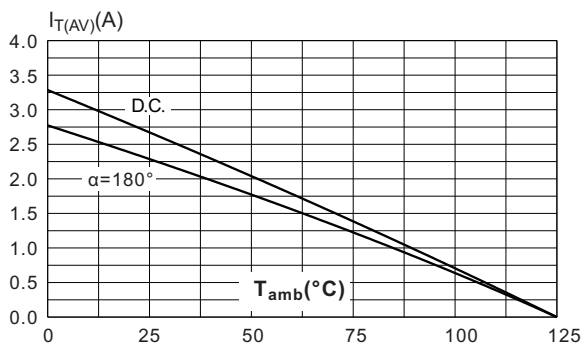

Fig.4 Relative variation of thermal impedance versus pulse duration.

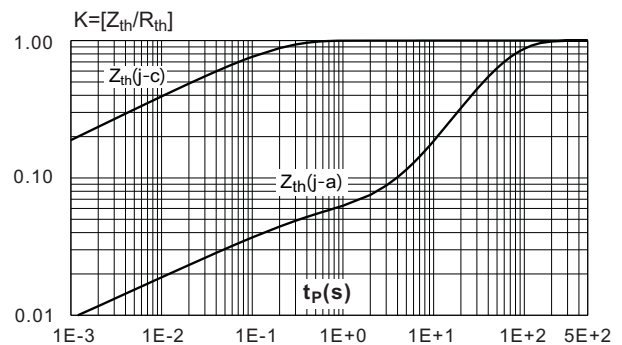

Fig.5 Relative variation of gate trigger current, holding current and latching current versus junction temperature.

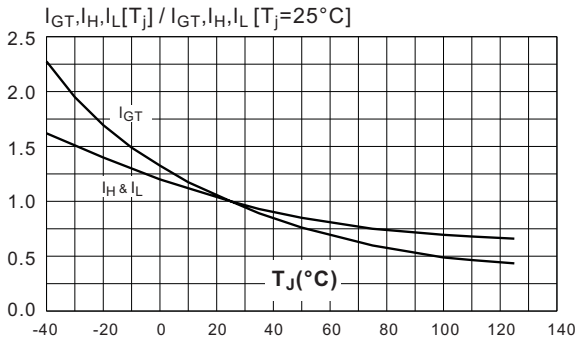

Fig.6 Surge peak on-state current versus number of cycles.

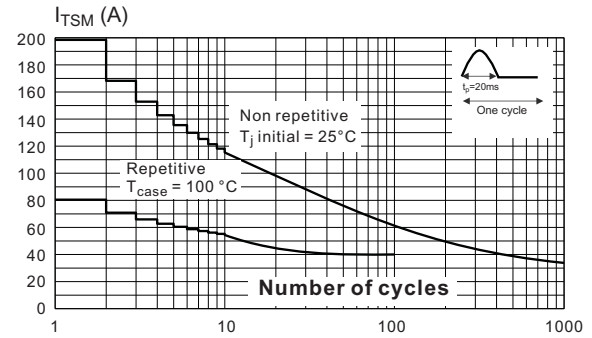

Fig.7 Non-repetitive surge peak on-state current for a sinusoidal pulse with width $t_p < 10$ ms, and corresponding values of I^2t

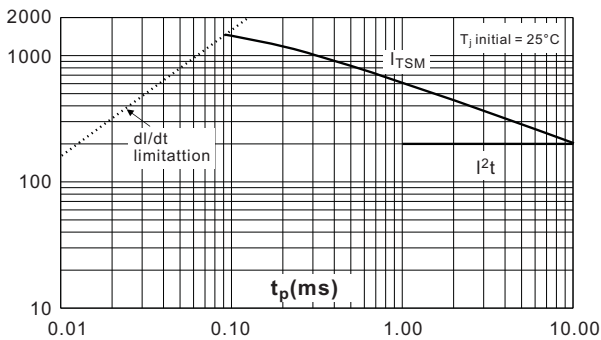

Fig.8 On-state characteristics (maximum values)

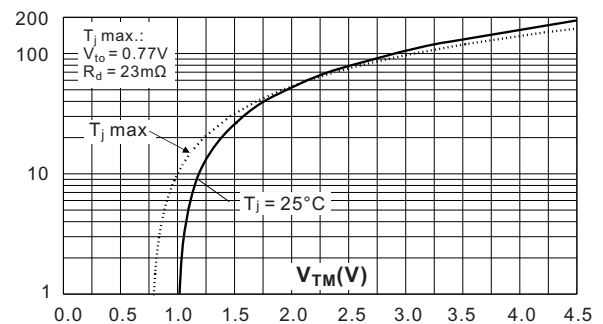
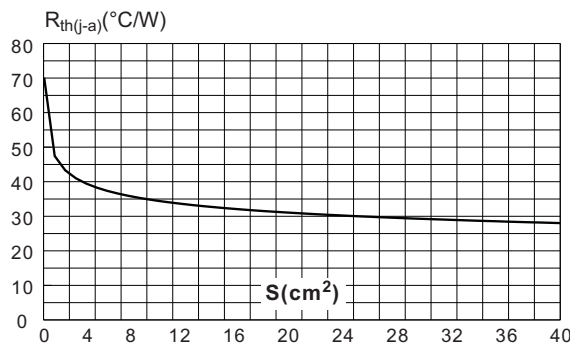
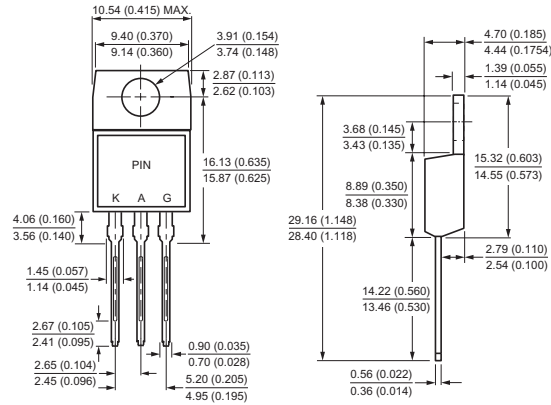

Fig.9 Thermal resistance junction to ambient versus copper surface under tab (epoxy printed circuit board Fr4, copper thickness: 35 μm) (D^2PAK)



Case Style

TO-220AB



TO-263(D²PAK)

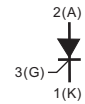
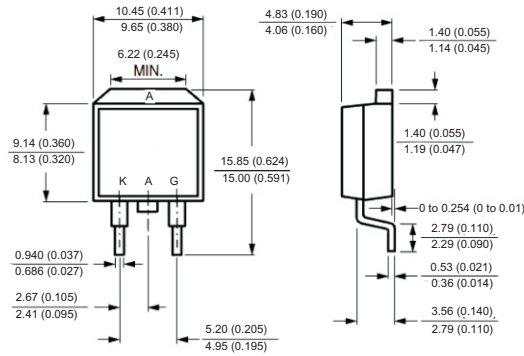

All dimensions in millimeters(inches)